

# 4. Supplementary Information

## 4-1 Current Transfer Ratio (CTR), LED Trigger Current (I<sub>FT</sub>) Ranking and Marking

Standard rank classifications are applied for the CTR of transistor-type photocouplers and for the I<sub>FT</sub> of MOSFET, SCR, Triac-type photocouplers. Indicative product markings corresponding to rank names are as shown below. Also, note that the applied rank classifications depend on product types.

### 1) CTR Rank Name and Rank Marking

Available CTR Rank Selection (○: Available, △: Call Toshiba)

Product No.	Rank Name								Rank Marking Group
	A or None	YG	GB	Y	GR	BL	GRL	GRH	
TLP180	○		○						1
TLP181	○		○	○	○	○	△	△	1
TLP280	○		○						1
TLP280-4	○		○						2
TLP281	○		○	○	○	○			1
TLP281-4	○		○						2
TLP321	○		○		△				1
TLP321-2/-3/-4	○		○						2
TLP421/421F	○		○	○	○	○			1
TLP521-1	○	○	○	○	○	○	○	○	1
TLP521-2	○		○		○	○			2

Product No.	Rank Name								Rank Marking Group
	A or None	YG	GB	Y	GR	BL	GRL	GRH	
TLP521-4	○		○		△				2
TLP531/532	○	○	○	△	○	○	△	△	1
TLP620	○		○		○				2
TLP620-2	○		○		△				2
TLP620-4	○		○						2
TLP621	○	○	○	○	○	○	○	○	1
TLP621-2	○		○		○	△			2
TLP621-4	○		○		△				2
TLP630	○		○						2
TLP631/632	○		○		○	△			1
TLP731/732	○		○		○		△	△	1
TLP733F/734F	○		○		○		△	△	1

#### i) Marking for Group 1

Rank Name	CTR	CTR Rank Marking
A or None	50 % to 600 %	Blank, Y, Y■, G, G■, B, B■, GB
YG	50 % to 300 %	Y, Y■, G, G■
GB	100 % to 600 %	GB, G, G■, B, B■
Y	50 % to 150 %	Y, Y■
GR	100 % to 300 %	G, G■
BL	200 % to 600 %	B, B■
GRL	100 % to 200 %	G
GRH	150 % to 300 %	G■

#### ii) Marking for Group 2

Rank Name	CTR	CTR Rank Marking
A or None	50 % to 600 %	Blank, YG, GB, GR, BL
GB	100 % to 600 %	GB, GR, BL
GR	100 % to 300 %	GR
BL	200 % to 600 %	BL

### 2) I<sub>FT</sub> Rank Name and Rank Marking

Rank Name	IFT	IFT Rank Marking
None	IFT Max	Blank, T7, T5
IFT7	7 mA Max	T7, T5
IFT5	5 mA Max	T5

### 3) Safety Standard Certification

Use Toshiba standard product number for safety standard certificate application.

Example : TLP621 (GR) → TLP621

#### Marking Example

##### i) 4pin Type & Mini Flat 1ch Type

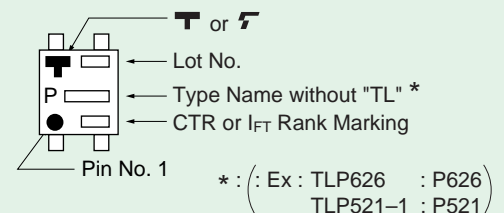

##### ii) Others

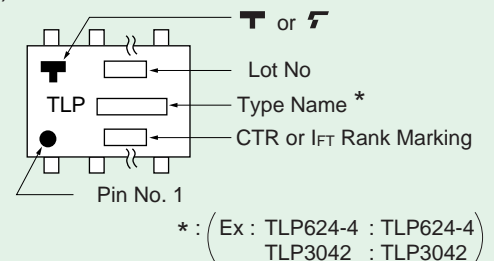

##### iii) TLP421

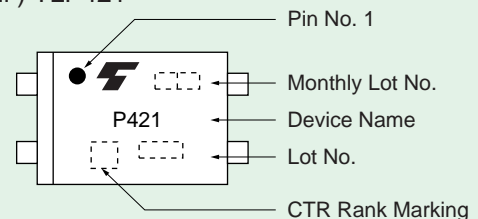

#### Label example

TYPE	TLP421		
ADD.C	(D4-GR)	Q'TY	PCS.
NOTE			

## 4-2 Optional Lead Formed Products

### 1) Surface-Mount Lead Form Options

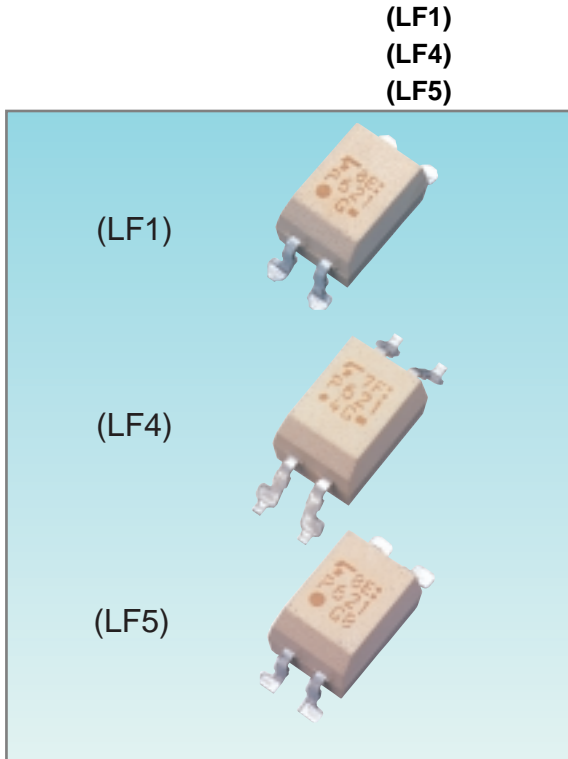

- The photocopier product line with lead forming is available for surface mounting.
- Features
  - Surface mountable
  - Available for all 4, 6, 8 & 16pin DIP
  - All electrical parameters remain unchanged from standard package

- Ordering Information  
To order any standard photocopier with a surface mount lead form, add : (LF1), (LF4) or (LF5) to the standard part number, depending on the lead form desired.

Example :

Standard product number : TLP731 (GR)

Surface-mount type product number :

TLP731 (GR-LF1), TLP731 (GR-LF4) or  
TLP731 (GR-LF5)

- Safety Standards Certification  
Use TOSHIBA standard part number for safety standards certificate application.

Example :

TLP731 (GR-LF1) → TLP731

### Package Dimensions

4pin (DIP4)

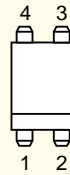

8pin (DIP8)

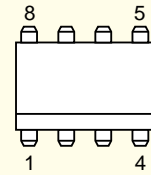

6pin (DIP6)

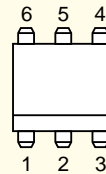

16pin (DIP16)

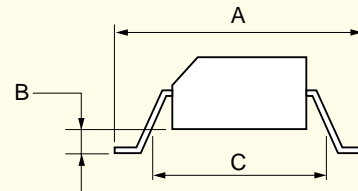
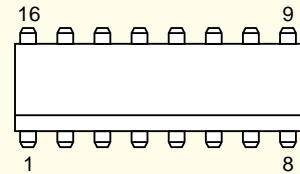

Unit: mm

Version	(LF1)		(LF4)		(LF5)	
	Min	Max	Min	Max	Min	Max
Dimension A	—	10.0	—	12.0	—	10.0
Dimension B	(0.35 typ.)		(0.25 typ.)		—	0.2
Dimension C	6.4	—	8.0	—	6.4	—

All other package dimensions are the same as for each standard package specifications.

## 2) Wide Clearance Lead Form Option

(LF2)

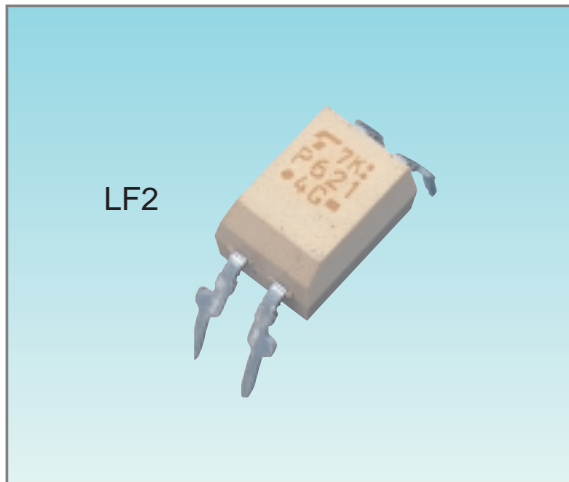

- The photocoupler line is available with lead forming for insertion mounting with wider clearance.
- Features
  - High board clearance
  - Available for all 4, 6, 8 & 16pin DIP
  - All electrical parameters remain unchanged from standard package
- Ordering Information  
To order any standard photocoupler with an wide clearance lead form, add : (LF2) to the standard part number.

Example :

Standard product number : TLP731 (GR)  
wide clearance product number : TIP731  
(GR-LF2)

- Safety Standards Certification  
Use TOSHIBA standard part number for safety standards certificate application.

Example :

TLP731 (GR-LF2) → TLP731

### Package Dimensions

4pin (DIP4)

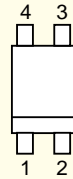

8pin (DIP8)

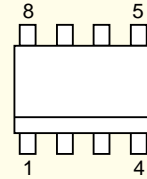

6pin (DIP6)

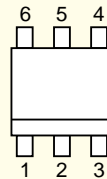

16pin (DIP16)

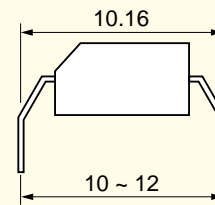
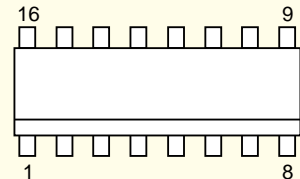

Unit: mm

All other package dimensions are the same as for each standard package specifications.

## 4-3 Photocoupler Magazine Packing Specifications

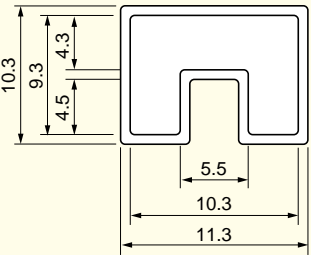
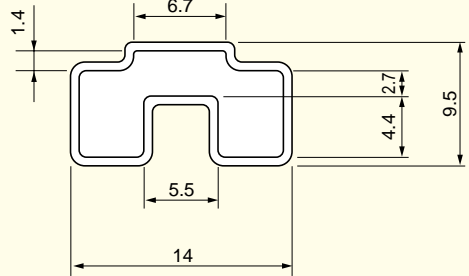
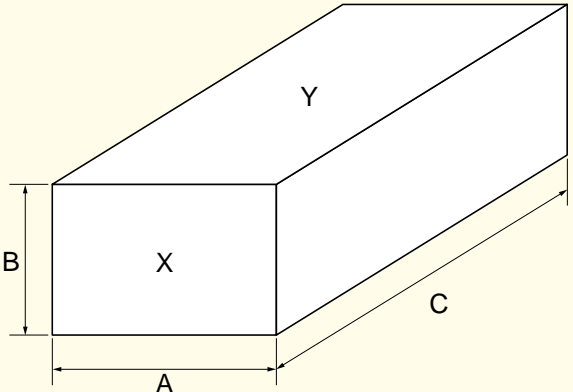
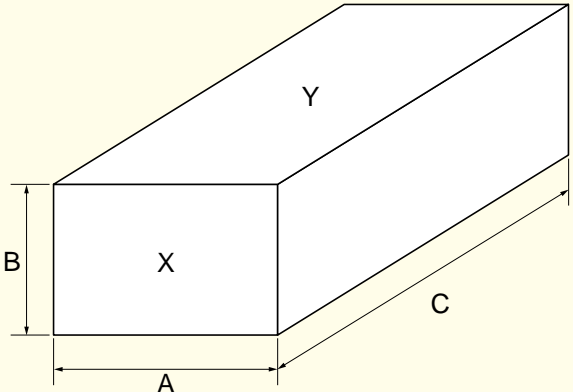
DIP Standard Lead Forming	DIP LF1, LF2, LF4 and LF5																					
<p><b>Dimensions of Magazine</b> <span style="float: right;">Unit: mm</span></p>  <p style="text-align: center;">Length = 525 Thickness = 0.5</p>	<p><b>Dimensions of Magazine</b> <span style="float: right;">Unit: mm</span></p>  <p style="text-align: center;">Length = 525 Thickness = 0.5</p>																					
<p><b>Quantities of Devices per Magazine</b></p> <table border="1" style="margin: auto; border-collapse: collapse; text-align: center;"> <thead> <tr style="background-color: #F08080;"> <th>Number of Pins</th> <th>4</th> <th>6</th> <th>8</th> <th>12</th> <th>16</th> </tr> </thead> <tbody> <tr> <td style="background-color: #D8BFD8;">Quantity (pcs)</td> <td>100</td> <td>50</td> <td>50</td> <td>25</td> <td>25</td> </tr> </tbody> </table>		Number of Pins	4	6	8	12	16	Quantity (pcs)	100	50	50	25	25									
Number of Pins	4	6	8	12	16																	
Quantity (pcs)	100	50	50	25	25																	
<p><b>Packing Dimensions</b> <span style="float: right;">Unit: mm</span></p> 	<p><b>Packing Dimensions</b> <span style="float: right;">Unit: mm</span></p> 																					
<table border="1" style="width: 100%; border-collapse: collapse; text-align: center;"> <thead> <tr style="background-color: #F08080;"> <th>Quantity of Magazines</th> <th>Dimensions (A x B x C)</th> <th>Label Position</th> </tr> </thead> <tbody> <tr> <td style="background-color: #D8BFD8;">4</td> <td>50 x 12 x 531</td> <td>Y</td> </tr> <tr> <td style="background-color: #D8BFD8;">20</td> <td>67 x 51 x 559</td> <td>Y</td> </tr> <tr> <td style="background-color: #D8BFD8;">60</td> <td>123 x 76 x 568</td> <td>X</td> </tr> </tbody> </table>	Quantity of Magazines	Dimensions (A x B x C)	Label Position	4	50 x 12 x 531	Y	20	67 x 51 x 559	Y	60	123 x 76 x 568	X	<table border="1" style="width: 100%; border-collapse: collapse; text-align: center;"> <thead> <tr style="background-color: #F08080;"> <th>Quantity of Magazines</th> <th>Dimensions (A x B x C)</th> <th>Label Position</th> </tr> </thead> <tbody> <tr> <td style="background-color: #D8BFD8;">4</td> <td>60 x 13 x 531</td> <td>Y</td> </tr> <tr> <td style="background-color: #D8BFD8;">40</td> <td>135 x 58 x 568</td> <td>X</td> </tr> </tbody> </table>	Quantity of Magazines	Dimensions (A x B x C)	Label Position	4	60 x 13 x 531	Y	40	135 x 58 x 568	X
Quantity of Magazines	Dimensions (A x B x C)	Label Position																				
4	50 x 12 x 531	Y																				
20	67 x 51 x 559	Y																				
60	123 x 76 x 568	X																				
Quantity of Magazines	Dimensions (A x B x C)	Label Position																				
4	60 x 13 x 531	Y																				
40	135 x 58 x 568	X																				

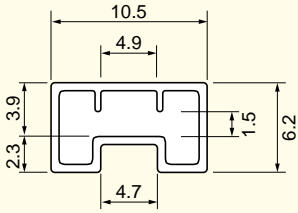
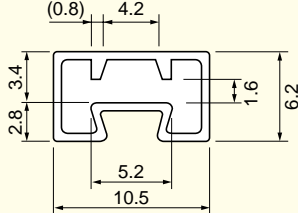
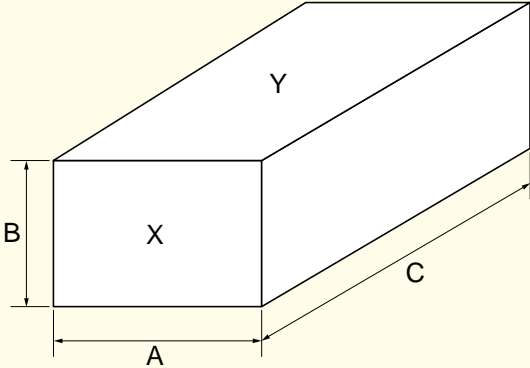
MFSOP (Mini-Flat Coupler)	SOP (SOP4, SOP16, 2.54 SOP)																			
<p><b>Dimensions</b> <span style="float: right;">Unit: mm</span></p>  <p style="text-align: center;">Length = 555 Thickness = 0.5</p>	<p><b>Dimensions</b> <span style="float: right;">Unit: mm</span></p>  <p style="text-align: center;">Length = 555 Thickness = 0.5</p>																			
<p><b>Quantities of Devices per Magazine</b></p> <table border="1" data-bbox="158 923 762 1029"> <tr> <td>Package Type</td> <td>MFSOP6</td> </tr> <tr> <td>Quantity (pcs)</td> <td>150</td> </tr> </table>	Package Type	MFSOP6	Quantity (pcs)	150	<table border="1" data-bbox="837 923 1442 1029"> <tr> <td rowspan="2">Package Type</td> <td rowspan="2">SOP4</td> <td rowspan="2">SOP16</td> <td colspan="3">2.54 SOP</td> </tr> <tr> <td>4pin</td> <td>6pin</td> <td>8pin</td> </tr> <tr> <td>Quantity (pcs)</td> <td>150</td> <td>50</td> <td>100</td> <td>75</td> <td>50</td> </tr> </table>	Package Type	SOP4	SOP16	2.54 SOP			4pin	6pin	8pin	Quantity (pcs)	150	50	100	75	50
Package Type	MFSOP6																			
Quantity (pcs)	150																			
Package Type	SOP4	SOP16	2.54 SOP																	
			4pin	6pin	8pin															
Quantity (pcs)	150	50	100	75	50															
<p><b>Packing Dimensions</b> <span style="float: right;">Unit: mm</span></p>  <table border="1" data-bbox="837 1408 1449 1659"> <thead> <tr> <th>Quantity of Magazines per Box</th> <th>Dimensions (A x B x C)</th> <th>Label Position</th> </tr> </thead> <tbody> <tr> <td>4</td> <td>29 x 13 x 563</td> <td>Y</td> </tr> <tr> <td>24</td> <td>77 x 31 x 586</td> <td>X</td> </tr> <tr> <td>40</td> <td>67 x 55 x 586</td> <td>X</td> </tr> </tbody> </table>		Quantity of Magazines per Box	Dimensions (A x B x C)	Label Position	4	29 x 13 x 563	Y	24	77 x 31 x 586	X	40	67 x 55 x 586	X							
Quantity of Magazines per Box	Dimensions (A x B x C)	Label Position																		
4	29 x 13 x 563	Y																		
24	77 x 31 x 586	X																		
40	67 x 55 x 586	X																		

Photocoupler Package Type	Typical Devices
MFC (MFSOP6)	TLP180, TLP114A, TLP160J, TLP3110
SOP-1ch (SOP4)	TLP280, TLP281
SOP-4ch (SOP16)	TLP280-4, TLP281-4, TLP270D, TLP270G
SOP (2.54SOP4)	TLP197G, TLP176G, TLP206G
SOP (2.54SOP6)	TLP197G
SOP (2.54SOP8)	TLP206G, TLP206A

## 4-4 Photocoupler Tape and Reel Specifications

### 1) Type (Surface-mount photocouplers are available on tape and reel as described below).

Photocoupler Package Types	Tape Option Symbol	Typical Devices
MFSOP6	(TPL) or (TPR)	TLP114A, TLP160J, TLP181, TLP190B
SOP4	(TP)	TLP280, TLP281
SOP16	(TP)	TLP280-4, TLP281-4, TLP270G, TLP270D
2.54SOP	(TP)	TLP176G, TLP197G, TLP206G
DIP(LF1, LF5)	(TP1) or (TP5)	TLP550, TLP560G, TLP621
DIP(LF4)	(TP4)	TLP251, TLP560G, TLP621

### 2) Tape Dimensions

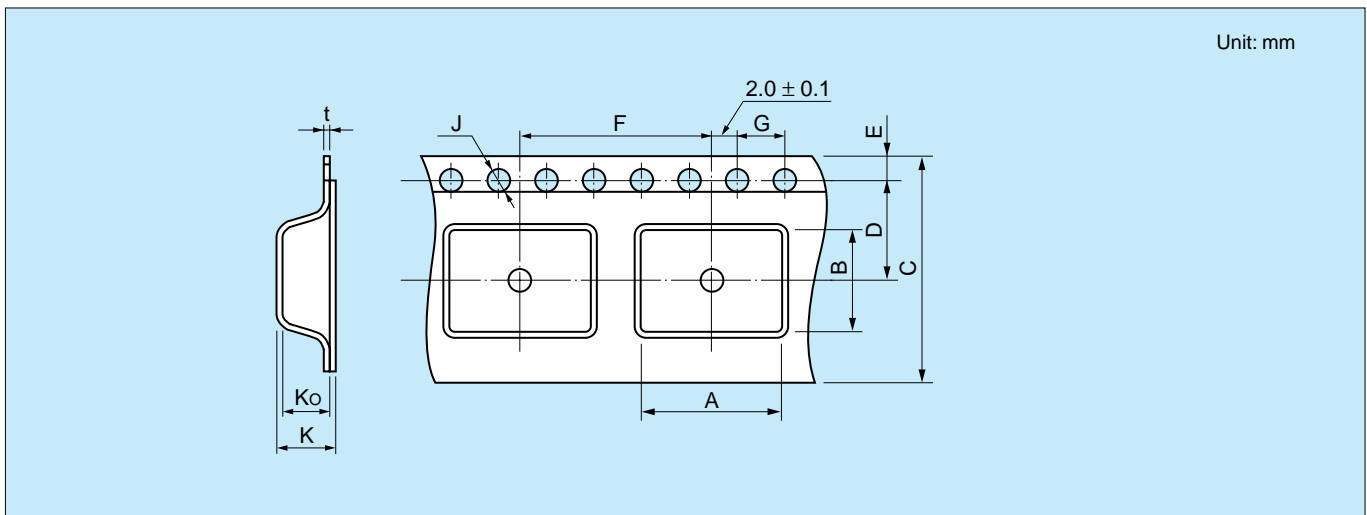

Unit: mm

Photocoupler Package Type	MFSOP6	SOP4	SOP16	2.54SOP4	2.54SOP6	2.54SOP8	DIP(LF1, LF5)	DIP(LF4)	
Tape Option :	(TPL), (TPR)	(TP)	(TP)	4pin	6pin	8pin	(TP1), (TP5)	(TP4)	
Dimension symbol (See Figure)	A	4.2 ± 0.1	3.1 ± 0.1	7.5 ± 0.1	4.3 ± 0.1	7.5 ± 0.1		10.4 ± 0.1	12.3 ± 0.1
	B	7.6 ± 0.1	7.5 ± 0.1	10.5 ± 0.1	7.5 ± 0.1	6.7 ± 0.1	10.5 ± 0.1	*1	*1
	C	12.0 ± 0.3		16.0 ± 0.3	12.0 ± 0.3	16.0 ± 0.3			
	D	5.5 ± 0.1		7.5 ± 0.1	5.5 ± 0.1	7.5 ± 0.1			
	E	1.75 ± 0.1							
	F	8.0 ± 0.1		12.0 ± 0.1	8.0 ± 0.1	12.0 ± 0.1			16.0 ± 0.1
	G	4.0 ± 0.1							
	J	1.5 <sup>+0.1</sup> <sub>-0</sub>							
	K	3.15 ± 0.2	2.5 ± 0.2	2.4 ± 0.2	2.6 ± 0.2	2.5 ± 0.2	2.4 ± 0.2	4.55 ± 0.2	
	Ko	2.8 ± 0.1	2.3 ± 0.1	2.2 ± 0.1	2.4 ± 0.1	2.3 ± 0.1	2.2 ± 0.1	4.1 ± 0.1	
	t	0.3 ± 0.05						0.4 ± 0.05	

\*1: Typical devices

DIP 4pin	TLP620, TLP621, TLP721	5.1 ± 0.1
DIP 6pin (short package)	TLP631, TLP734, TLP747G, TLP3022 (S)	7.6 ± 0.1
DIP 6pin (long package)	TLP598G, TLP3052	10.1 ± 0.1
DIP 8pin	TLP250, TLP555, TLP2601	(TP4) is not available.

### 3) Reel Dimensions

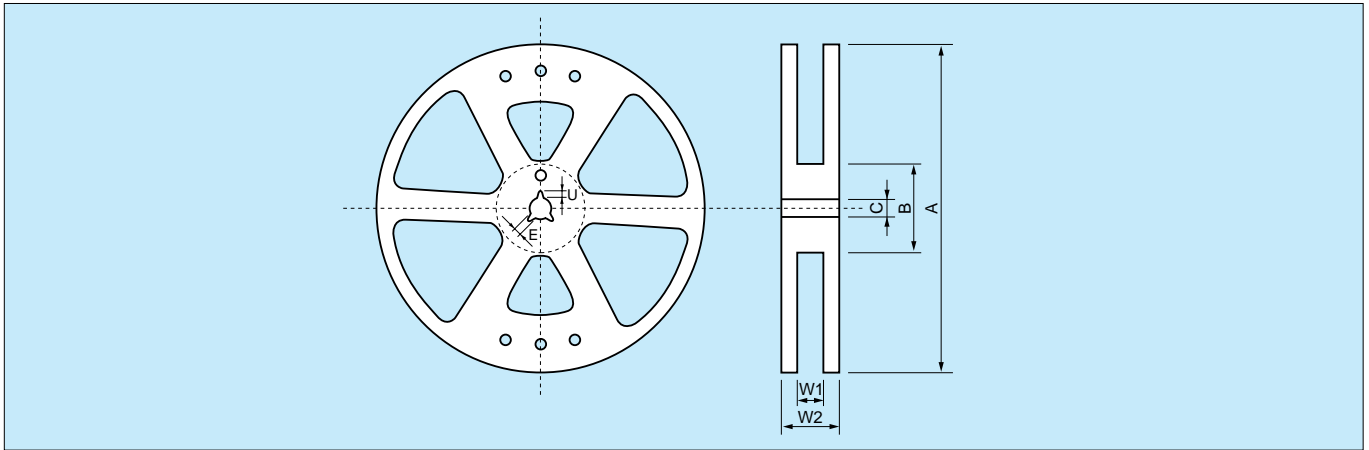

Unit in mm

Photocoupler Package Type		MFSOP	SOP4	SOP16	2.54SOP4	2.54SOP6	2.54SOP8	DIP(LF1, LF5)	DIP(LF4)
Tape Options :		(TPL), (TPR)	(TP)	(TP)	(TP)			(TP1), (TP5)	(TP4)
Symbol	A	$\phi 380 \pm 2$	$\phi 330 \pm 2$				$\phi 380 \pm 2$		
	B	$\phi 80 \pm 1$							
	C	$\phi 13 \pm 0.5$							
	E	$2.0 \pm 0.5$							
	U	$4.0 \pm 0.5$							
	W1	$13.5 \pm 0.5$	$17.5 \pm 0.5$	$13.5 \pm 0.5$	$17.5 \pm 0.5$				
	W2	$17.5 \pm 1.0$	$21.5 \pm 1.0$	$17.5 \pm 1.0$	$21.5 \pm 1.0$				

### 4) Other Packing Information

a) Device orientation on tape, by combinations of photocoupler package type and tape options.

Tape orientation

The diagrams show three different carrier tape configurations. The first two show three devices on a tape with two circular holes above them. The third shows three devices on a tape with a row of eight circular holes above them.

Photocoupler Package Type	Tape Option
MFSOP6	TPR

Photocoupler Package Type	Tape Option
MFSOP6	TPL
SOP4, 2.54SOP4	TP

Photocoupler Package Type	Tape Option
SOP16	TP
2.54SOP6/8	TP
DIP (LF1, LF5)	TP1, TP5
DIP (LF4)	TP4

## 4-4 Photocoupler Tape and Reel Specifications (continued)

### b) Details of Tape

#### ● Quantities per Reel

Photocoupler Package Type	MFSOP6	SOP4	SOP16	2.54SOP4/6/8	DIP (LF1, LF5)	DIP (LF4)
Quantities (pcs)	3000	2500	2500	2500	1500	1000

#### ● Empty Cavities :

Item	Specification	Note
Consecutive empty cavities	Zero	Any 40 mm portion of tape except leader and trailer.
Nonconsecutive empty cavities	0.2% max/reel ※ 2	Except leader and trailer.

※ 2 : 6pcs max/reel for DIP types

### c) Packing boxes

2 types : One-reel box or five-reel box.

### d) Label

The reel label includes the following information.

1. Product number 2. Tape type 3. Quantity 4. Lot number

### e) Purchase order

Specify the product number, tape and quantity as follows.

ex. **TLP181 (GB-TPR) 3000pcs**

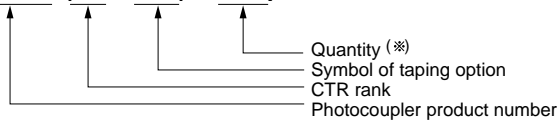

※ Per reel must be a multiple of quantity



## 4-5 Recommended Footprint Dimensions

Below are the recommended footprint (mount pad) dimensions for surface-mount packages. (Units in mm)

### 1) Mini-Flat Coupler (MFSOP, 2.54SOP, SOP)

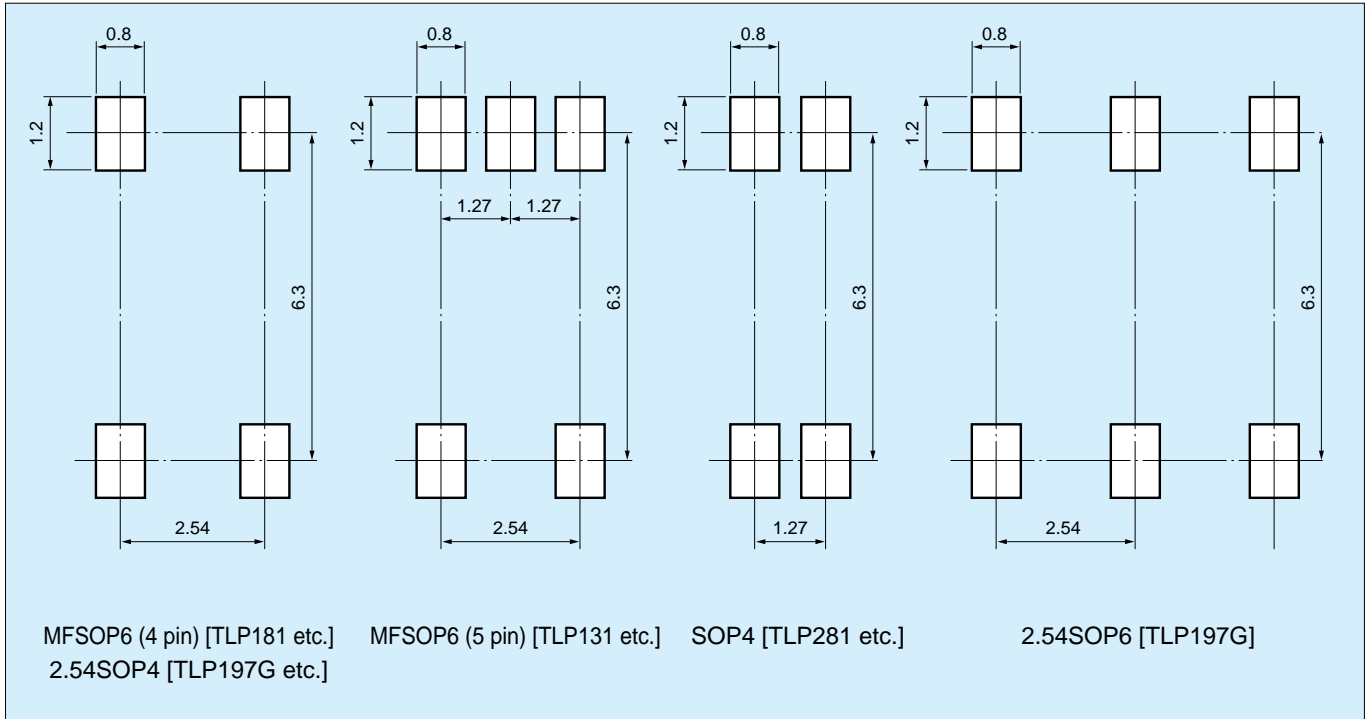

### 2) SMD Lead Forming of 6-pin DIP Coupler

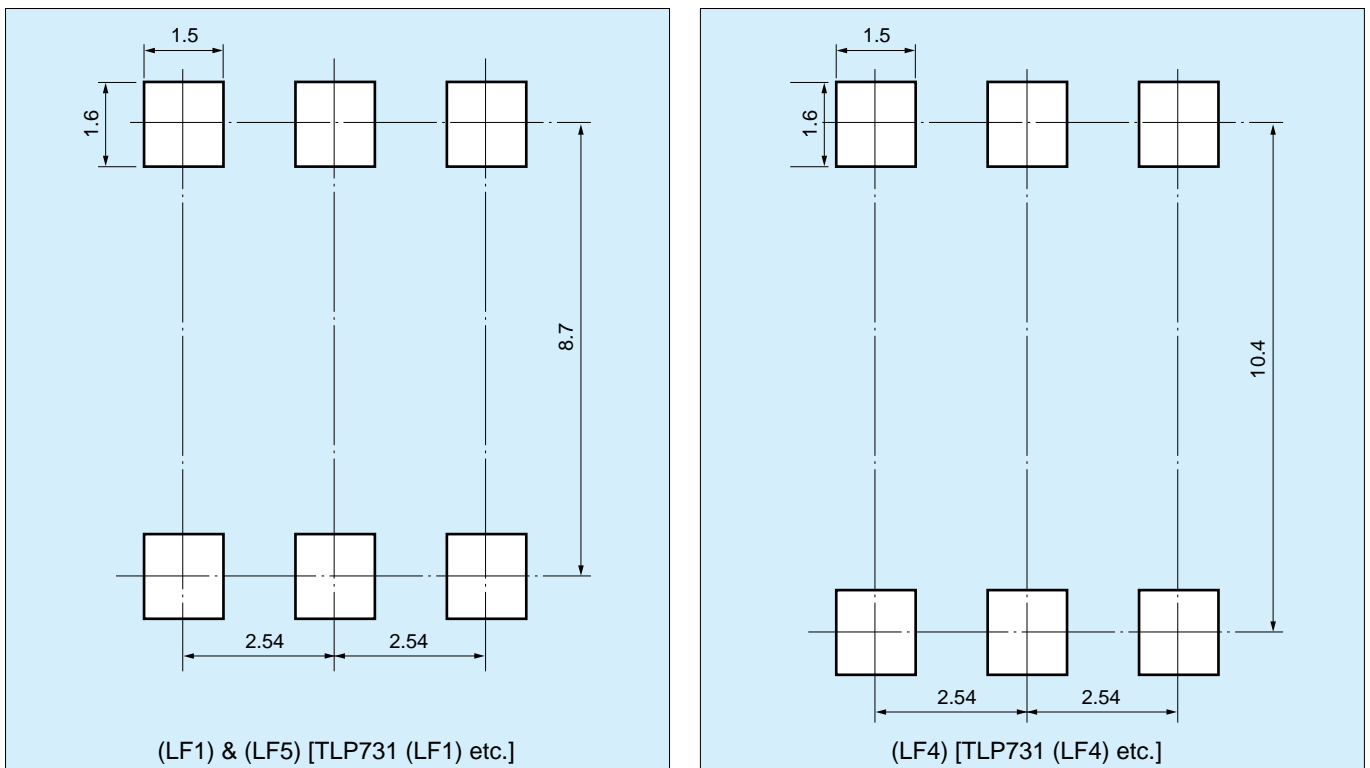

## 4-6 Precautions for Assembly Using Mini Flat Coupler

### 1) Soldering

Avoid rise in the device temperature as much as possible by observing the following conditions.

**a) Soldering lead directly (by solder header)**

260°C max, 10 second max, for once.

**b) Reflow soldering**

(1) Complete the reflow process for once within 30 second at a package surface temperature above 210°C.

(2) Atmospheric temperature close to mold body surface : 240°C max, 10 second max

(3) Recommended temperature profile

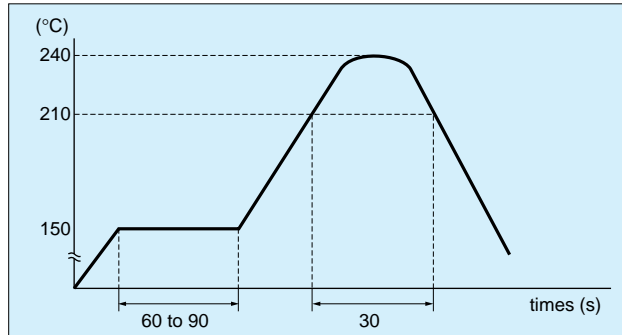

**c) Precautions for heating**

(1) Soldering time has to be kept as short as possible.

(2) When using a halogen lamp or infrared heater, please do not irradiate the mold body surface directly.

**d) Dip soldering (Flow soldering)**

Reflow soldering is recommended, because thermal stress is much less than in other soldering methods.

Contact Toshiba when you plan to use dip soldering.

### 2) Cleaning

**2-1) The following types of solvents are recommended for cleaning the flux.**

Toshiba Technocare (FRW-1, FRW-17, FRW-100)

Kao Cleanthru 750H

Asahi Clean AK-225AES

Pine-alpha ST-100S

**2-2) Cleaning Conditions**

Cleaning conditions and precautions may differ depending on the product specifications.

When cleaning the flux, reactive ions such as Cl and Na must be removed.

**a) General precautions on dip cleaning**

Dipping time may differ depending on the solvent used.

However, as a general reference, it is recommended to limit the dip 3 minutes.

**b) General precautions on ultrasonic cleaning**

When ultrasonic cleaning is conducted for excessively long times, contact between product resin and metal leads may lessen. Also, excessive ultrasonic stress may cause cracks in the pellet.

It is recommended to apply a minimum of stress.

Recommended conditions for standard ultrasonic cleaning

Frequency : 27 to 29kHz

Time : 30 seconds or less

Output : 0.25 W/ cm<sup>2</sup> or less

Temperature : 50°C (may differ depending on the solvent used)

Cleaning must be conducted in a condition in which the printed circuit board or device should be floating on the solvent used in order to avoid direct contact with the ultrasonic vibrator.





**2-3) Handling Precautions**

During cleaning, or when cleaning liquid is being applied to a device, do not touch the device-marking surface with hand or brush. Device markings may be erased.

It is necessary to confirm the safety of the solvent used for cleaning, as well as cleaning conditions, so as not to harm the device package.

## 4-7 Safety Standard Approved Photocouplers and VDE0884-Approved Photocouplers

(as of September 2000)

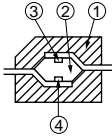
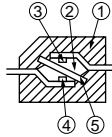
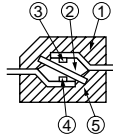
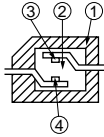
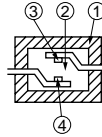
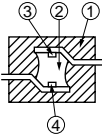
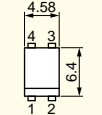
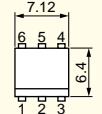
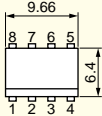
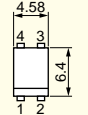
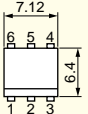
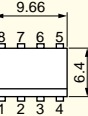
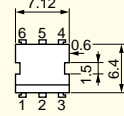
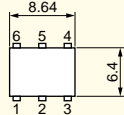
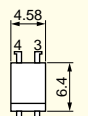
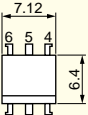
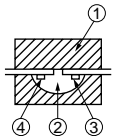
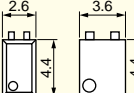
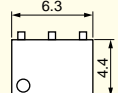
		TLP521-1 TLP531/532 TLP541G/545J TLP550/551 TLP560G/561G	TLP620/-2/-4 TLP621/-2/-4 TLP750/751 TLP631/632 TLP641G/641J TLP651 TLP30xx(S) Series	TLP731/732 TLP741G TLP741J TLP3022 TLP3052 TLP3042 TLP3062	TLP733/734 TLP747G TLP747J TLP762J TLP763J	TLP121 TLP131 TLP112A TLP115A TLP180 TLP181 TLP280 TLP281	TLP127 TLP160G TLP141G TLP190B TLP197G TLP176G TLP206G
Safety Standard		TLP227G TLP227G-2 TLP250 TLP251 TLP597G	TLP620/-2/-4 TLP621/-2/-4 TLP627/-2/-4 TLP750/751/759 TLP30xx(S) Series	TLP731/732 TLP741G TLP741J TLP3022 TLP3052 TLP3042 TLP3062 TLP668JF TLP798G	TLP733/734 TLP747G TLP747J TLP762J	TLP165J TLP166J TLP181 TLP280 TLP281	TLP127 TLP176G TLP197G TLP206G
		TLP227G TLP227G-2 TLP597G	TLP620/-2/-4 TLP621/-2/-4 TLP624/-2/-4 TLP626/-2/-4 TLP627/-2/-4 TLP750/751	TLP731/732 TLP741G TLP741J TLP798G	TLP733/734 TLP747G TLP747J TLP762J TLP763J	TLP180 TLP181 TLP280 TLP281	TLP127 TLP176G TLP197G TLP206G
		TLP227G TLP227G-2 TLP597G	TLP620/-2/-4 TLP621/-2/-4 TLP624/-2/-4 TLP626/-2/-4 TLP627/-2/-4 TLP750/751	TLP731/732 TLP741G TLP741J TLP798G	TLP733/734 TLP747G TLP747J TLP762J TLP763J	TLP180 TLP181 TLP280 TLP281	TLP127 TLP176G TLP197G TLP206G
		TLP227G TLP227G-2 TLP597G	TLP620/-2 TLP621/-2 TLP627/-2 TLP750/751/759 TLP30xx(S) Series	TLP798G	TLP733/734 TLP747G TLP747J TLP762J TLP763J	TLP180 TLP181 TLP280 TLP281	TLP176G TLP197G TLP206G
Construction (Cross-section)	<ul style="list-style-type: none"> <li>① Body</li> <li>② Window</li> <li>③ Detector</li> <li>④ LED</li> <li>⑤ Film</li> </ul>						
Package Dimensions (Unit: mm)		  	  	 	 	<p style="text-align: center;"><b>TLP181/TLP281</b></p>   	

## 4-7 Safety Standard Approved Photocouplers and VDE0884-Approved Photocouplers

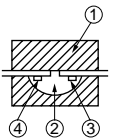
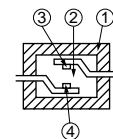
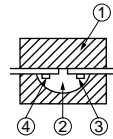
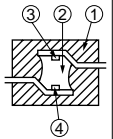
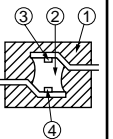
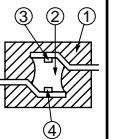
Device Type		4pin and Multichannel	TLP181**/ TLP180	—	—	TLP280/TLP281	—	—	
		Transistor Output	—	TLP131	—	—	—	—	—
Thyristor Output	—	—	—	—	—	TLP141G	—	—	
Triac Output	—	—	TLP165J/ TLP166J	—	—	TLP160J/ TLP161J	—	—	
IC Output	—	TLP114A	—	—	—	—	—	—	
Photorelay	—	—	—	—	—	—	TLP176G TLP206G	—	
Construction Mechanical Ratings (min)		Package	MFSOP		SOP		MFSOP	2.54SOP	
		Isolation Creepage Path (mm)	4.0		4.0		4.0		
		Isolation Clearance (mm)	4.0		4.0		4.0		
		Isolation Thickness (mm)	0.4	—		0.4	—		
		Internal Creepage Path (mm)	—		—		—		
		Isolation Voltage (kVrms)	3.75		2.5		2.5		1.5
		Internal Construction (Cross Section)	① Body ② Window ③ Detector ④ LED ⑤ Film						
Safety Standard	UL	UL1577 (File No. E67349)	Parts Specifications	●	●	●	●		
		Double Protection	—	—	—	—			
	VDE	DIN VDE 0884/08.87	Parts Specifications	● <sup>**</sup> (Note 1)	○	● (Note 1)	○	○	
		DIN IEC65/ VDE 0860/08.81	Home Appliances	○	○	○	○		
		DIN IEC380/ VDE 0806/08.81	Office Equipment	○	○	○	○		
		DIN IEC435/ VDE 0805/08.79	Data processing Equipment	○	○	○	○		
		DIN57 804 VDE 0804/01.83	Data processing Equipment	○	○	◎	○		
		DIN57 700T1/ VDE 0700T1/2.81	Home Appliances	○	○	○	○		
		DIN IEC601T1/ VDE 0750T1/05.82	Medical Equipment	○	○	○	○		
	BSI	BS EN60065: 1994	Home Appliances	●	○	●	○	●	
BS EN60950: 1992		Office Equipment	●	○	●	○	●		
BS6301: 1989		Telecommunications Networks	●	○	●	○	●		
SEMKO	SEMKO SS-EN60950	Office Equipment	—	—	—	—	—		

\*\* : Only applied for TLP181

Note 1 : VDE0884 standards for MFSOP and SOP photocouplers are different from those of standard DIP photocouplers because MFSOP and SOP are compact and small packages.

Device Type	4pin and Multichannel	TLP624/626	TLP621*/620/627	—	—	—	—	TLP421	
	Transistor Output	—	—	TLP733/734	—	TLP731/732	—	—	
	Thyristor Output	—	—	TLP747G/ TLP747J	—	TLP741G/ TLP747J	—	—	
	Triac Output	—	—	—	TLP762J/ TLP763J	—	TLP3022F/3052F TLP3042F/3062F	—	
	IC Output	—	TLP750/ TLP751	—	—	—	—	—	
	Photorelay	—	—	—	—	—	—	—	
Construction Mechanical Ratings (min)	Package	DIP		DIP		DIP		DIP	
	Isolation Creepage Path (mm)	6.4	7.0		7.0		7.0		
	Isolation Clearance (mm)	6.4	8.0 (Note 2)		8.0 (Note 2)		8.0 (Note 2)		
	Isolation Thickness (mm)	0.4	0.5	0.4	0.5		0.4		
	Internal Creepage Path (mm)	—	4.0		—		—		
	Isolation Voltage (kVrms)	5.0	4.0		4.0	5.0	5.0		
	Internal Construction (Cross Section)	① Body ② Window ③ Detector ④ LED ⑤ Film							
Safety Standard	UL	UL1577 (File No. E67349)	Parts Specifications	●	●	●	●	●	
		Double Protection	—	●*	●	—	—		
	DVE	DIN VDE 0884/08.87	Parts Specifications	○	● (Note 3)	● (Note 3)	● (Note 3)	● (Note 3)	● (TUV) (Note 3)
		DIN IEC65/VDE 0860/08.81	Home Appliances	○	○	○	○	○	
		DIN IEC380/VDE 0806/08.81	Office Equipment	○	○	○	○	○	
		DIN IEC435/VDE 0805/08.79	Data processing Equipment	○	○	○	○	○	
		DIN57 804 VDE 0804/01.83	Data processing Equipment	○	○	○	○	○	
		DIN57 700T1/VDE 0700T1/2.81	Home Appliances	○	○	○	○	○	
		DIN IEC601T1/VDE 0750T1/05.82	Medical Equipment	○	○	○	○	○	
		BSI	BS EN60065: 1994	Home Appliances	●	●	●	●	●
	BS EN60950: 1992		Office Equipment	●	●	●	●	●	
	BS6301: 1989		Telecommunications Networks	●	●	●	●	●	
	SEMKO	SEMKO SS-EN60950	Office Equipment	● (Note 4)	●	—	●	●	

\*: Only applied for TLP621

Note 2: 8.0 for (LF2) or F type. Note 3: VDE0884-approved with option (D4).

Note 4: TLP621 / 620 / 627 / 750 / 751 are approved. TOSHIBA recommend TLP621 rather than TLP721 for your new designing.